

23.01.2018

Modelname / Model name / Nom du modčle / Modellnamn / Nome modello / Název modelu / Modelnaam / Ime modela / Numéro Modello / Modell neve / Название модели / Názov modelu / Ime modela / Denumire model / Наименование на модела / Nazwa modelu

-ATLANTA-

Туре / Tipo / Тіpus / Тур / Тип / Tip

55

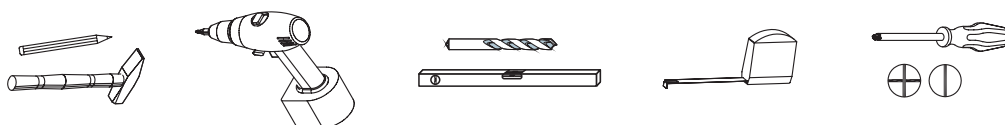
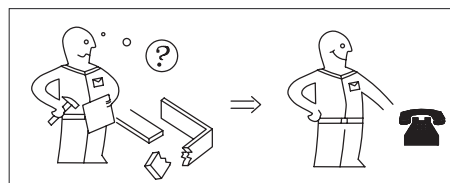
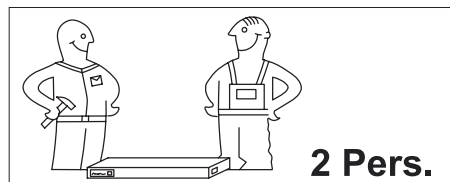
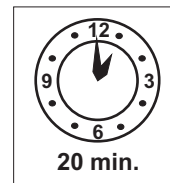
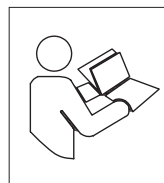
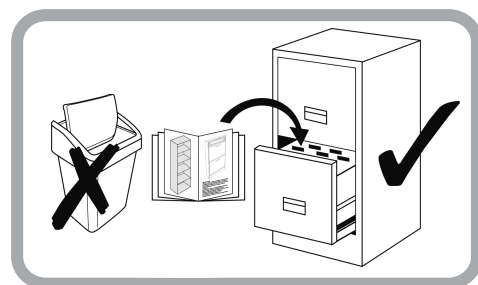
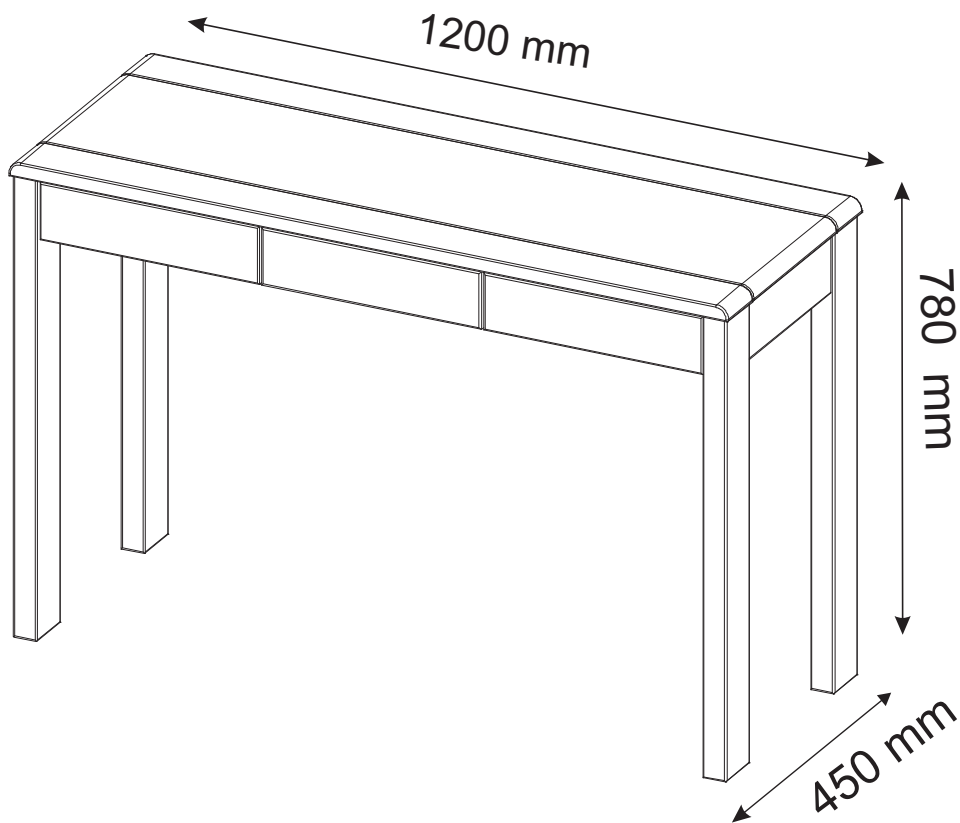

23.01.2018

Modelname / Model name / Nom du modèle / Modellnamn / Nome modello / Název modelu / Modelnaam / Ime modela / Número Modelo / Modell neve / Название модели / Názov modelu / Ime modela / Denumire model / Наименование на модела / Nazwa modelu

Type / Tipo / Típus / Тип / Тип / Tip

-ATLANTA-

55

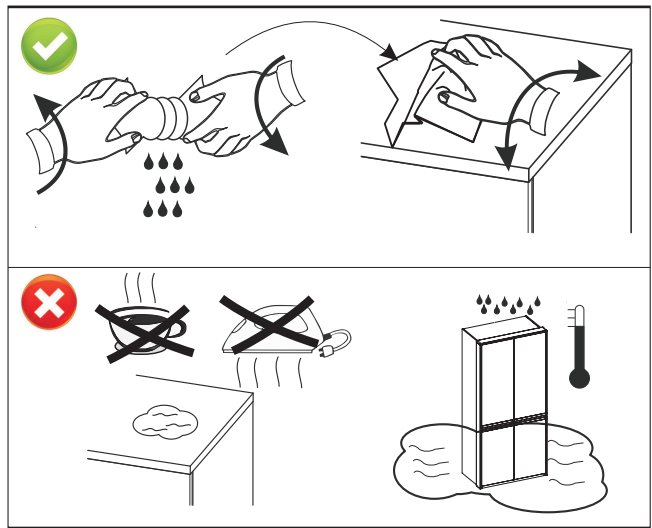
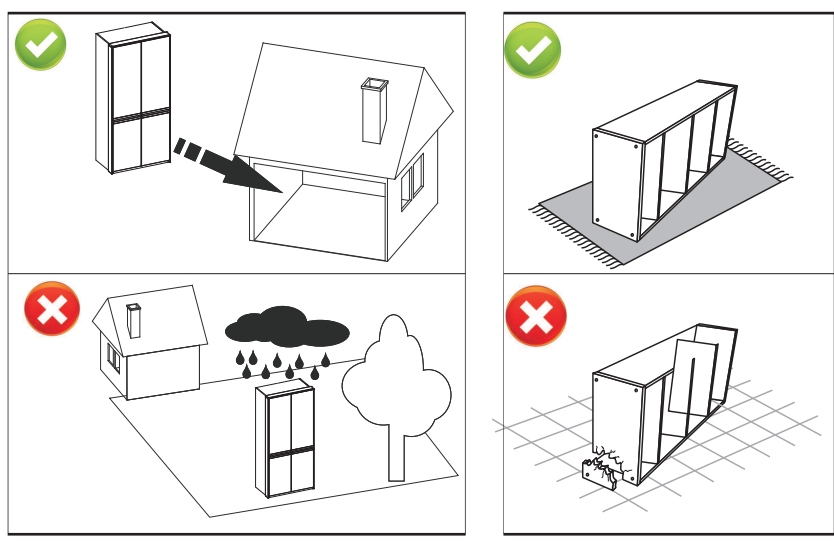
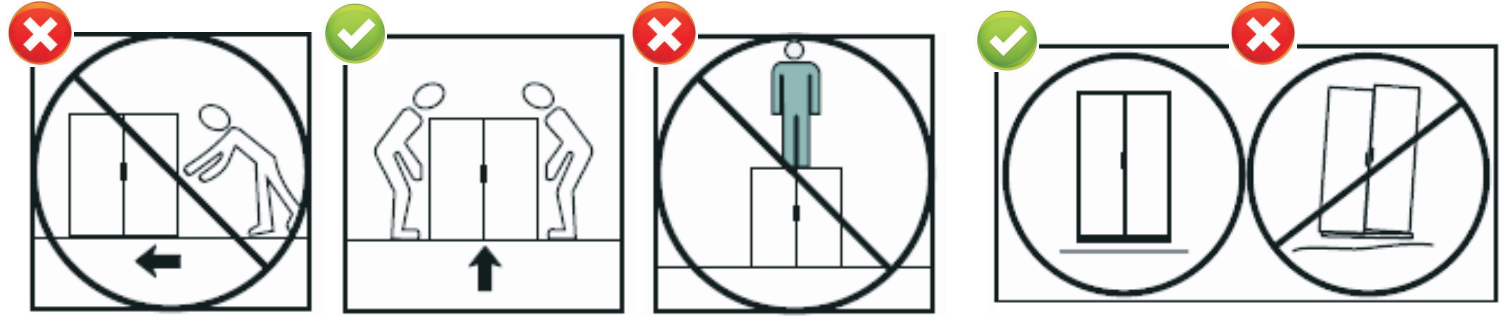

Tel: +48 601 247 625
 Tel: +48 601 677 210
 sprzedaz@dekortmeble.pl
 www.dekortmeble.pl

23.01.2018

Modelname / Model name / Nom du modèle / Modellnamn / Nome modello / Název modelu / Modelnaam / Ime modela / Número Modelo / Modell neve / Название модели / Názov modelu / Ime modela / Denumire model / Наименование на модела / Nazwa modelu

Type / Tipo / Típus / Тип / Тип / Tip

55

-ATLANTA-

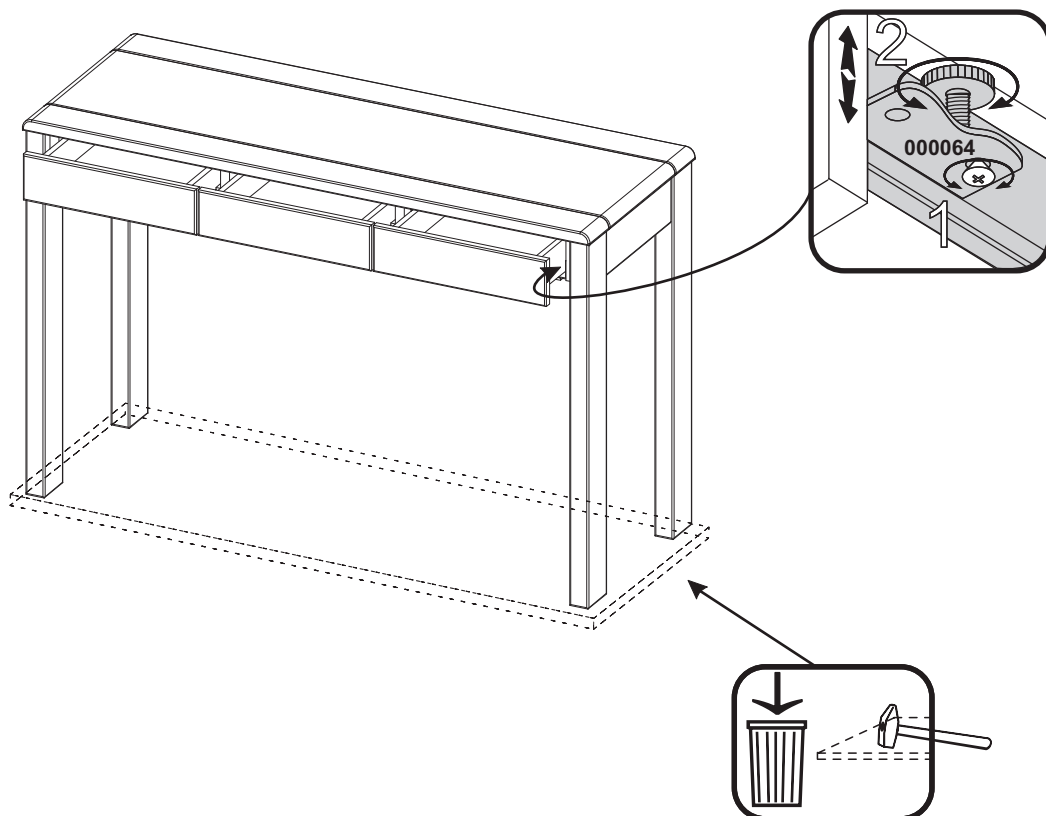
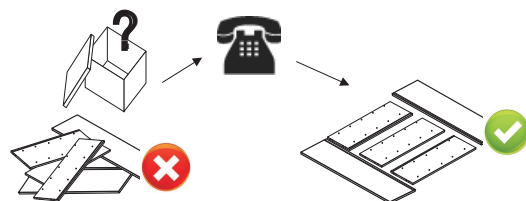
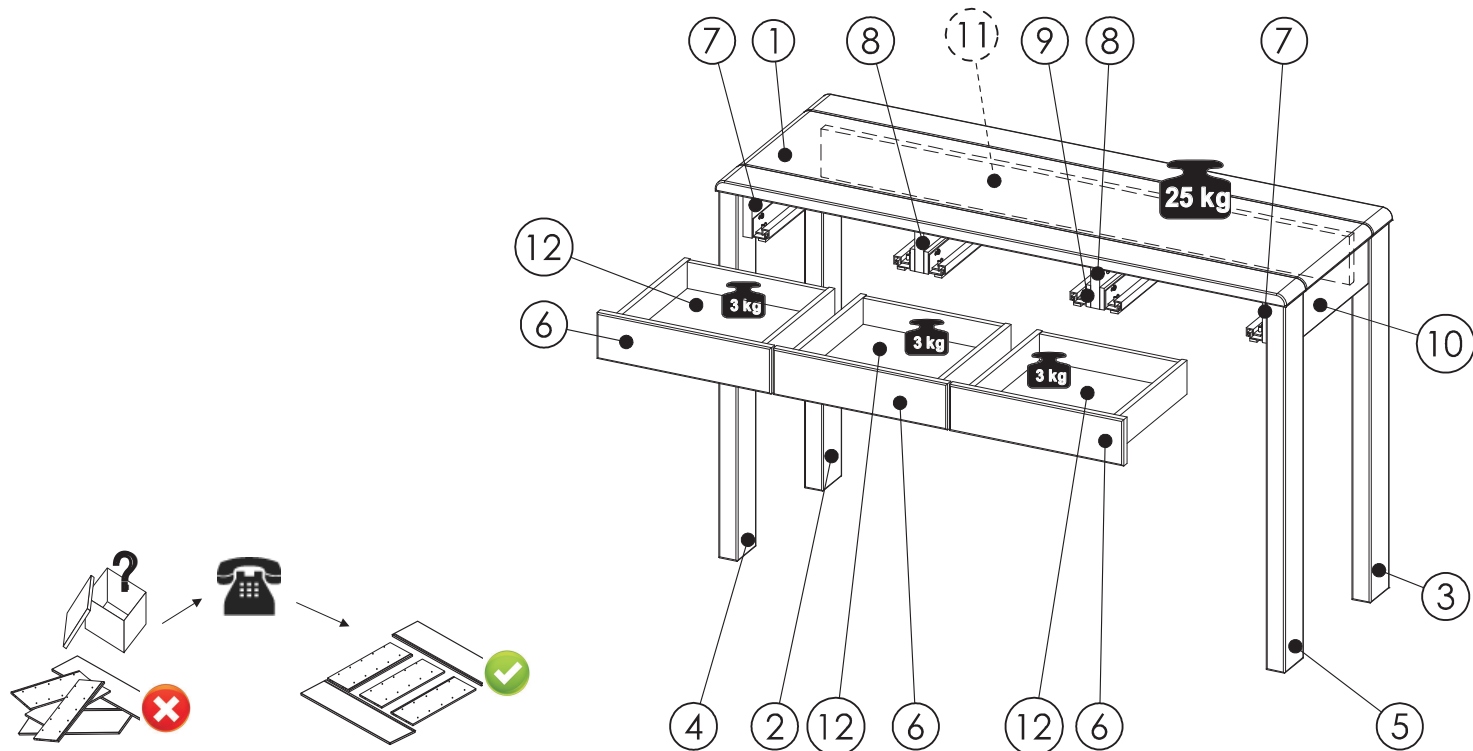

23.01.2018

Modelname / Model name / Nom du modèle / Modellnamn / Nome modello / Název modelu / Modelnaam /
Ime modela / Numéro Modello / Modell neve / Название модели / Názov modelu / Ime modela /
Denumire model / Наименование на модела / Nazwa modelu

Type / Tipo / Típus / Тип / Тип / Tip

-ATLANTA -

55

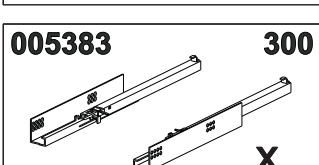
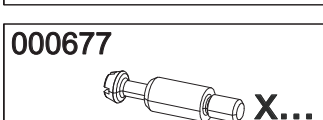
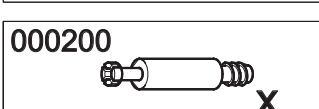
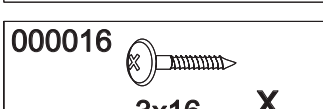
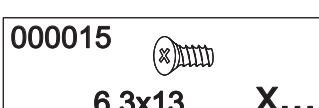
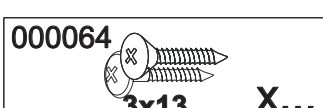
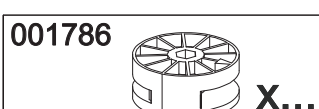
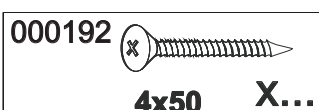
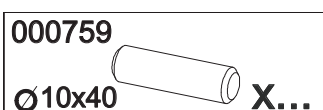
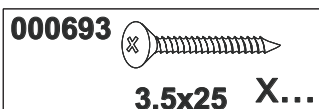
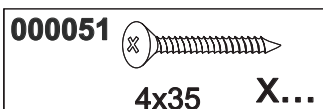
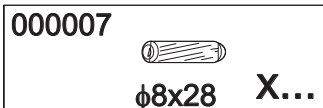
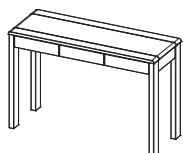

D Sehr geehrter Kunde. Wir gratulieren Ihnen zum Erwerb Ihres neuen Möbelstücks. Da wir auf die Zufriedenheit unserer Kunden viel Wert legen, bitten wir Sie, bevor Sie mit der Montage beginnen, den Beschlagbeutel sorgfältig zu überprüfen. Sollte ein Teil fehlen oder beschädigt sein, kreuzen Sie dieses deutlich auf der Montageanleitung an und schicken uns diese zu

GB Dear Customer. We would like to congratulate you buying a new furniture. Because we emphasize our customer satisfaction, please check very carefully the bag with fittings before you start assembling. If some parts are missing or are broken please mark it with „X” sign on assembly instruction and send it to us.

PL Szanowny Kliencie. Gratulujemy zakupu nowego mebla. Ponieważ kładziemy duży nacisk na zadowolenie naszego Klienta, prosimy dokładnie sprawdzić torbę z okuciami zanim zaczniecie montować. Gdyby brakowało jakiejś części lub byłaby uszkodzona proszę to oznaczyć krzyżykiem na instrukcji montażowej i przesłać instrukcję.

